



Facility Rental Information Packet



Table of Contents

Welcome.....	3
Facility Rental Information.....	4
Facility Rental Reservation Form.....	5
Facility Rental Contract.....	6
Facility Rental Guidelines.....	8
Catering Agreement.....	9
Classroom Layouts.....	10
Knox Gallery Layout.....	11
Powerstation and Theater.....	12
Upper and Lower Level Layout.....	13
Equipment Rental Form.....	14
Facility Rental Order Form.....	15
Preferred Catering List.....	16
Catering Checklist.....	17



Welcome

Thank you for your interest in renting the National Science Center's Fort Discovery. This packet contains helpful and useful information about our facility and the steps to take to ensure a wonderful experience. Also included are a Facility Rental Contract and the Catering Agreement that must be reviewed by you and your caterer, if you choose to have one, and a Catering Checklist that must be completed by the caterer before and immediately following your event.

Steps to a Successful Rental

1. Fill out the Facility Rental Reservation Form (page 5). Send the completed form and half of the rental fee to ensure your event is on the calendar.
2. Complete and return the Facility Rental Contract and Catering Agreement (pages 6 and 9) at least ONE month prior to your event. Caterer must also read and sign Catering Agreement.
3. Complete and return your floor plan layout and Equipment Rental Form (page 14).
4. The Facility Rental Order Form (page 15), balance of the rental fees, and equipment rental fees must be paid at least ONE week prior to your event. Security fees will be invoiced after event.
5. The Catering Checklist (page 17) must be completed and returned at the end of the event.

Please send these forms by mail, fax, or delivery to Elizabeth Corley, Sales and Special Events Coordinator at 1 Seventh Street, Augusta, GA 30901. All forms may be turned in together when the deposit is turned in.

Note: A tentative hold will be placed on the date until the deposit is received. If another party expresses interest in booking that date, you will be contacted to determine where you are in the decision-making process.

Last minute rentals may be possible if facility space is available. Special arrangements may be made with new deadlines for returning reservation forms and paying the fees for these events.

We hope you will choose the National Science Center's Fort Discovery for your event. Again, thank you and know we are happy to help you in any way. Please don't hesitate to call with questions or concerns you may have.

For more information, contact **Elizabeth Corley, Sales and Special Events Coordinator** at **706.821.0614** or **corleye@nscdiscovery.org**.



Facility Rental Information

Meeting Rooms	Dimensions	Theater	Classroom	Banquet	Reception	Rates
Theater	56 X 30	250	N/A	N/A	N/A	\$ 550.00
Classroom B	29 X 29	50	30	30	50	\$ 300.00
Classroom E	36 X 22	100	60	60	100	\$ 350.00
Classroom F	26 X 20	30	30	30	30	\$ 250.00
Classroom G	36 X 22	100	60	60	100	\$ 350.00
Upper Level	N/A	N/A	N/A	800+	1500	\$1250.00
Lower Level	N/A	N/A	N/A	800+	1500	\$1000.00
PowerStation	27 X 50	120	N/A	N/A	N/A	\$ 150.00
Knox Gallery	5000 sq. ft	300	N/A	300	300	\$ 750.00
Conference Room	30 X 15	N/A	12	N/A	N/A	\$ 250.00
Upper/Lower Level	N/A	N/A	N/A	1600+	3000+	\$2000.00

One of Augusta's most unique event locations, Fort Discovery offers a one-of-a-kind venue to create a truly special event. Whether it is a reception, company outing, special event or meeting space, let Fort Discovery provide a spectacular backdrop.

Fort Discovery offers exhibit galleries, classrooms, a conference room, PowerStation and the Paul S. Simon Discovery Theater.

Exhibit Galleries: Upper and/or Lower Levels are available and accommodate up to 1500 guests.

Classrooms: Multi-purpose facilities are available for presentations, meetings and private gatherings.

Conference Room: Accommodates up to 12 guests for meetings and presentations.

Paul S. Simon Discovery Theater: Stadium seating with full stage and accommodations for various presentations.

- Rates are based on 3 hour minimum rentals for the galleries and Theater.
- Classrooms are based on 4 hour rentals.
- Interpreters are included with the rental for the galleries to encourage your guests to interact with more than 250 interactive exhibits.
- Security is provided by Fort Discovery. In some instances, Richmond County may require the renter to use County Deputies and Fire Marshalls. These fees will be the responsibility of the Renter.

DEPOSITS ARE REQUIRED BEFORE RENTAL WILL BE CONFIRMED.



Facility Rental Reservation Form

Send the completed form below, and half of the rental fee, to ensure your event is on the calendar. Please use the Facility Rental Information Form (page 4) to complete this form.

Day and date of event: _____

Event Time: _____

Organization / Group: _____

Event Contact Person: _____

Daytime Phone: _____ Fax: _____

Address: _____

City: _____ State: _____ Zip: _____

Nature of event: _____

Number of guests: _____

Circle the location of your Rental

*Classroom B Classroom E Classroom F Classroom G Theater PowerStation Knox Gallery
Upper Level Lower Level Conference Room Upper/Lower Level*

How to calculate your rental fee:

Cost of Rental: _____

- (minus)

½ Rental Fee: _____

= (equals)

Cost of Deposit: _____

AMOUNT ENCLOSED WITH THIS FORM: \$ _____

I have enclosed a check _____ Money Order _____ Charge my Visa MasterCard AmEx

My credit card number is _____

Exp. Date _____ Name as it appears on card _____

Signature _____ Date _____



Facility Rental Contract

It is the policy of the National Science Center's Fort Discovery to permit use of the facility under certain conditions for educational purposes to make the center and its collections, exhibits and other programs more widely known to the public. Because of its status as a nonprofit organization and the need to comply with federal tax guidelines regarding related use, the Center must demonstrate that private functions benefit the Center in terms of educational and learning experiences and its programs to new audiences. All policies and regulations in this agreement are designed to safeguard the Center, its property and exhibits.

Specific Rules and Regulations

It is the responsibility of the Renter to ensure that the caterer and any other contracted service personnel understand and will abide by the following usage guidelines. It is advisable to give a copy of these regulations to all service personnel. *Please read all rules and regulations and sign at the bottom.*

1. The Renter agrees to assume responsibility for and indemnify the National Science Center's Fort Discovery from any injury to or loss by persons attending the event.
2. The Renter agrees to assume responsibility for theft or damage to the Center and its contents caused by anyone attending or present on the premises as a result of the event.
3. The Renter agrees to assume full responsibility for theft or damage to the Center's exhibits.
4. Renters are responsible for hiring any necessary additional help, such as bartenders, wait staff, coatroom attendants, florists, etc.
5. The Renter, caterer, and any service personnel hired must respect the security procedures in order to protect the Center and its exhibits and must follow any security-related requests made by the Center staff or security staff.
6. If a caterer is used, the Center reserves the right to approve or reject the Renter's selection. It is the responsibility of the Renter to ensure that the contracted caterer reads, understands and signs the Catering Agreement and the Catering Checklist.
7. It is the responsibility of the renting party to see that all city and state laws regarding the use of alcoholic beverages are followed. Renter must obtain alcohol licenses or permits if required. Bartenders must be at least 21 years of age. Alcoholic drinks cannot be served to minors and nonalcoholic drinks must be provided.
8. Alcohol service must stop at least 15 minutes prior to the end of your event.
9. Any publicity efforts mentioning the center must be discussed with and approved by the Marketing Department. All printed material related to the event must be discussed with the Marketing Department prior to the final printing. The Center logo may not be mentioned or duplicated without prior consent of the Marketing Department.
10. One person must be designated by the Renter to oversee the entire event, from setup through cleanup, and must be onsite during those times and during the event.
11. A member of the Center staff must be present for each event. Arrangements will be made when the rental reservation is confirmed.
12. Other than equipment provided by the Center, the Center's staff is not responsible for setup or breakdown of any equipment brought in by or for the Renter. All other needs must be secured through the caterer and/or Rental Company.



13. Deliveries must use the loading dock on the side of the building. The loading dock must be cleared immediately following unloading and loading. No parking is allowed in the loading dock area.
14. No signs may be placed outside or on the building without permission.
15. Floral arrangements must be clean and treated for pests before coming on site.
16. The Center reserves the right to approve the musician(s) for any event.
17. The Renter will be charged a fee for Security after 10:00pm on an hourly rate.
18. The Renter will be charged a fee for cleaning after the event. The classrooms, conference room and PowerStation fee is \$25.00. The Paul S. Simon Discovery Theater and galleries will be \$50.00.
19. In the event of cancellation 30 days or less prior to your event, the rental deposit (half of the rental fee) is non-refundable.
20. Smoking is not permitted anywhere in the building.
21. Renter has inspected the premises and accepts the use of it as is.
22. The Renter shall find the premises to be in a clean, safe condition and hereby agrees to leave said premises and surrounding areas of Fort Discovery in a clean, safe condition. The Renter is responsible for any damages caused by guests, agents, contractors and the like while facility is in use under this agreement.
23. Any additional services provided by the Center (i.e. audio/visual equipment and the like) will be arranged on a separate contract. This contract includes facility rental and normal services provided as outlined in the enclosed Facility Guidelines list.
24. In the event that the Center shall learn that the Renter intends to violate any terms, conditions or guidelines as stated in this contract and the enclosed Facility Guidelines, the Center reserves the right to cancel this contract and return 50% of the rental fee, if paid in full. If full payment has not been received, no monies will be refunded.
25. Prior to renting the classrooms, coordination will be conducted with the Engineering and Automation Department of Fort Discovery to establish how any additional software will be accessed on the PCs and/or through the network and to identify the configuration in which the computers will be left at the end of the rental period. This configuration can be specifically added to the contract prior to signing. Rental clients failing to return the systems to the designated configurations will be charged for four hours of staff manpower (\$100.00) to accomplish this reconfiguration.
26. Renter agrees and has read the Facility Rental Guidelines and House Rules.

I have read this policy of the National Science Center's Fort Discovery and agree to abide by them.

Please PRINT Name	Signature	Date
Elizabeth Corley, Sales and Special Events Coordinator For the National Science Center's Fort Discovery	_____	_____
	Signature	Date



Facility Rental Guidelines

The National Science Center, Inc. proudly makes Fort Discovery available for special events of all varieties and sizes. Our unique and interesting atmosphere offers an exciting alternative to other venues. The key to ensuring a successful function at our facility is advanced planning and a mutual understanding between the Center and the Renter.

We want your event at Fort Discovery to be the best ever! That is why our Sales and Special Events Coordinator will work with you to determine all of your servicing needs (i.e. table and chairs requirements, etc.) Please feel free to contact her with any questions and or concerns.

Please read the following House and Catering Rules, sign the last page and send back with your signed contract.

Fort Discovery House Rules

1. Food and beverage costs are not included in the rental fee; however, use of the catering kitchen is included.
2. Parking for the Renter and its guests, invitees, vendors or staff is not included in the rental fee. Group rates are given and can be paid through the contract or individually the night of the event.
3. All extra equipment (projectors, microphones, etc.) should be discussed with the Sales and Special Events Coordinator during contract negotiations.
4. Fort Discovery can supply white linen for the event for an additional charge of \$8.00 per linen. Please arrange this through the Sales and Special Events Coordinator during contract negotiations.
5. Birdseed, confetti, glitter and uncooked rice are prohibited on the premises. A protective mat must be used under kegs, fountains, ice sculptures, etc.
6. Fund raising events must be pre-approved by Fort Discovery.
7. Fort Discovery does not have dollies or carts for use. Please make arrangements to bring these items.

I have read this policy of the National Science Center's Fort Discovery and agree to abide by them.

Please PRINT Name of Renter

Signature

Date

Please PRINT Name of Caterer

Signature

Date



Catering Agreement

As the Renter is responsible for ensuring that these policies are adhered to, it is advised that the Renter provide a copy of these policies to the caterer at least one month prior to the event. A city ordinance requires that all caterers be licensed, insured and have a current health inspection.

1. All applicable "House Rules" regarding catering, set-up and the like must be followed.
2. Caterers are responsible for bringing any necessary kitchen supplies (i.e. dish detergent, rags, towels, utensils, etc.) and are responsible for maintaining cleanliness in the kitchen area during use.
3. Discarding food or any other solid items in the sink drains is prohibited. We do not have a garbage disposal.
4. Trashcans are provided by the Center. Caterers are responsible for properly bagging garbage and carrying it to the trash dumpster outside the loading dock. Boxes must be broken down prior to disposal. Trashcans must be rinsed out at the conclusion of their use.
5. Caterers may have to share the kitchen with other caterers. Distribution of appropriate space and equipment will be determined by the Sales Department. The Renter will be notified if sharing of the kitchen will be necessary.
6. Caterers must be aware of the need for security. All vehicles and non-public facility doors should remain locked.
7. It is required that the caterer meet on-site with the Sales and Special Events Coordinator at least 2 weeks prior to the event to review the menu, tour the kitchen and facility, discuss layout for tables and serving stations and review facility policies. The Renter is responsible for coordinating a convenient time with the caterer.
8. The coordinator will walk through the kitchen area before the caterer leaves.
9. The kitchen is equipped with a refrigerator, freezer, warming ovens, triple sink and work space. No cooking is allowed in the building. Doors to the kitchen cannot be left unlocked.
10. Caterers must check in with the Center's security upon arrival in the Center.
11. The catering kitchen is located on the first floor. There is one service elevator for personnel and deliveries.
12. Sterno, Canned Heat, or canned gas must be supervised at all times by an attendant.
13. Caterers are responsible for food & drink clean up during and following the event.

I have read this policy of the National Science Center's Fort Discovery and agree to abide by them.

Please PRINT Name of Renter

Signature

Date

Please PRINT Name of Caterer

Signature

Date



Please indicate location of tables, etc., by drawing the placement on this map.

Classroom B

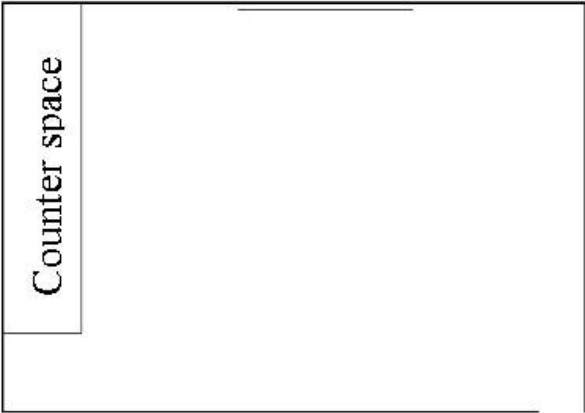

Classroom E

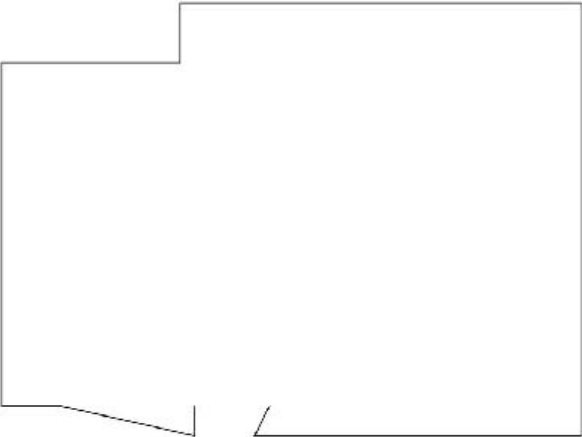

Classroom F

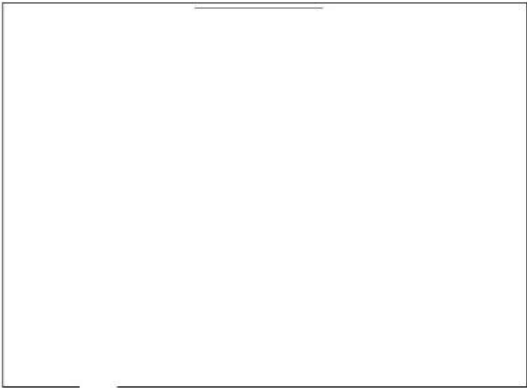

Classroom G

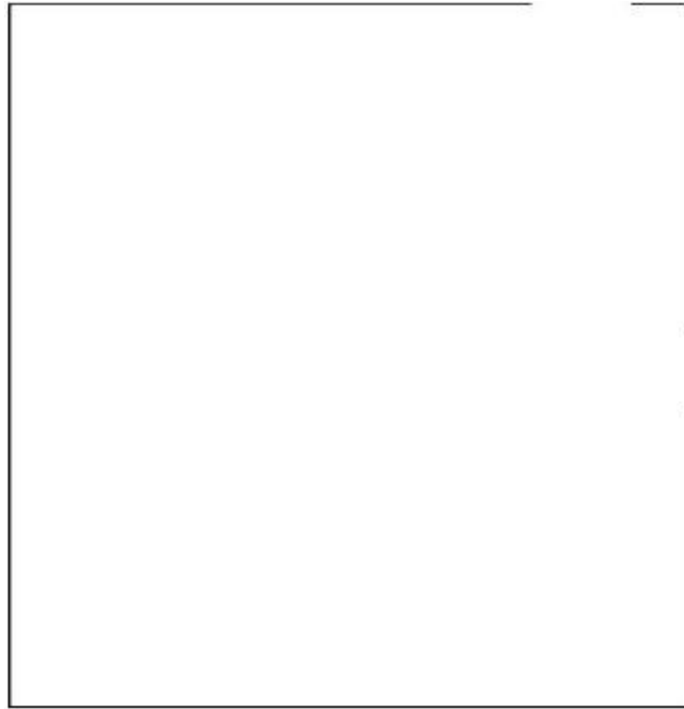

Knox Gallery

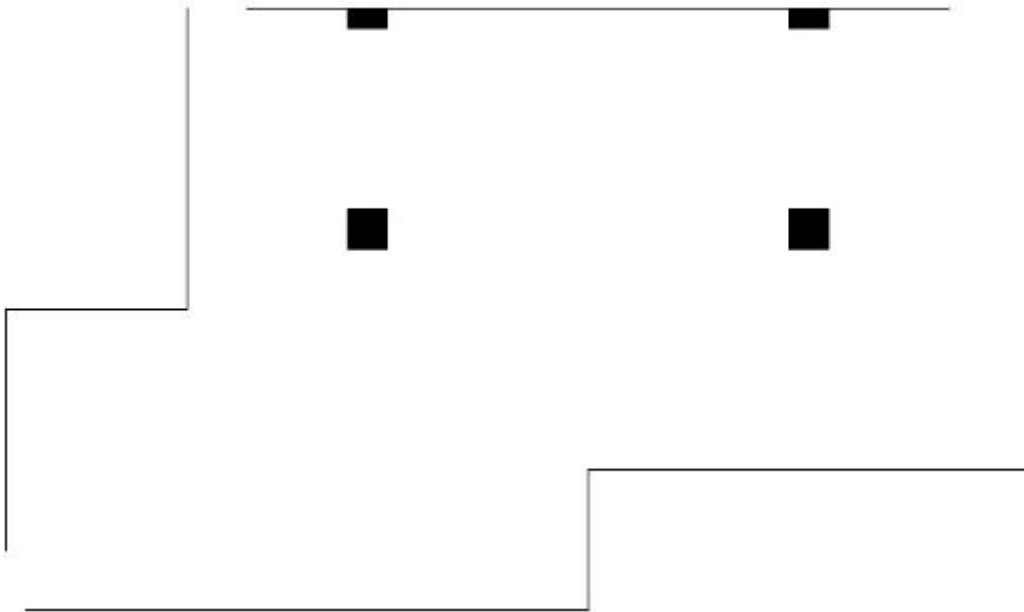

Power Station

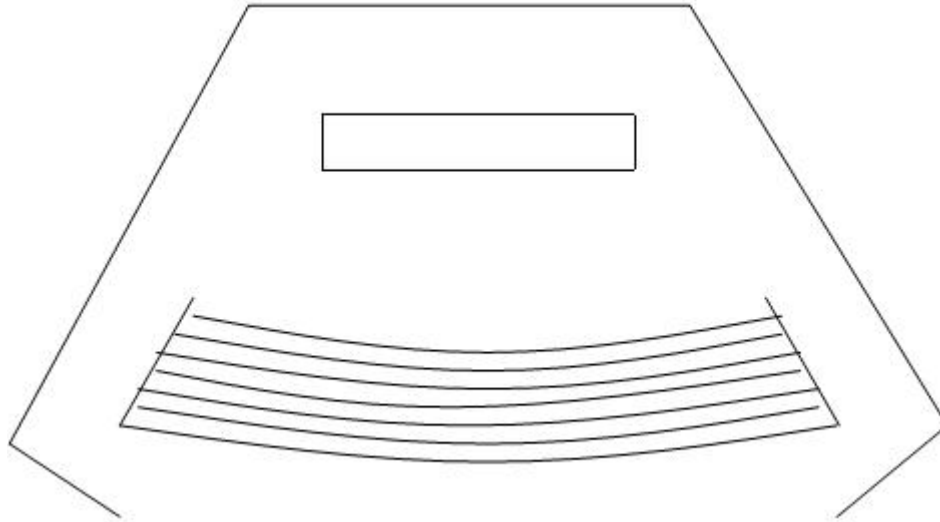

Paul S. Simon Discovery Theater

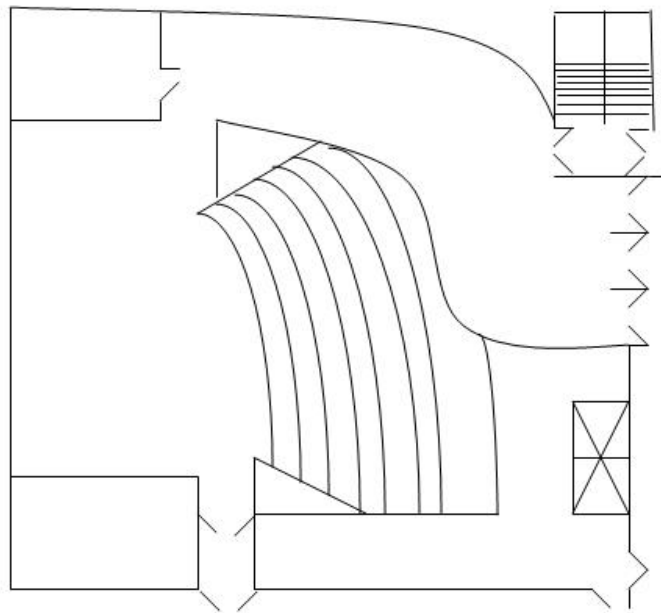

Upper Level

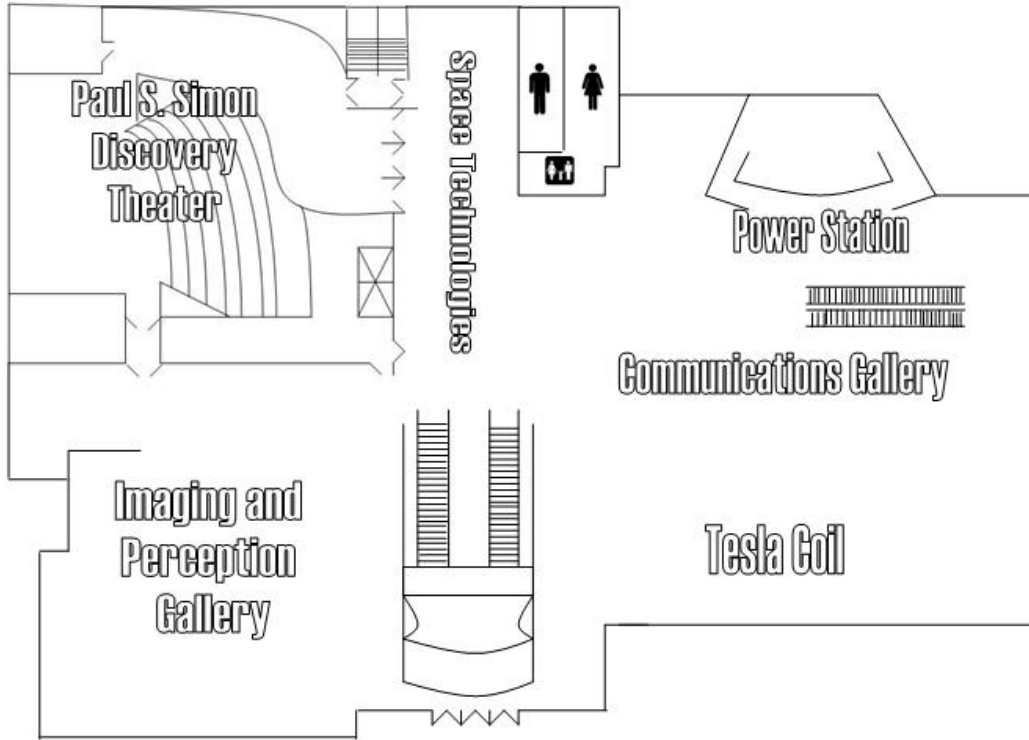

Lower Level

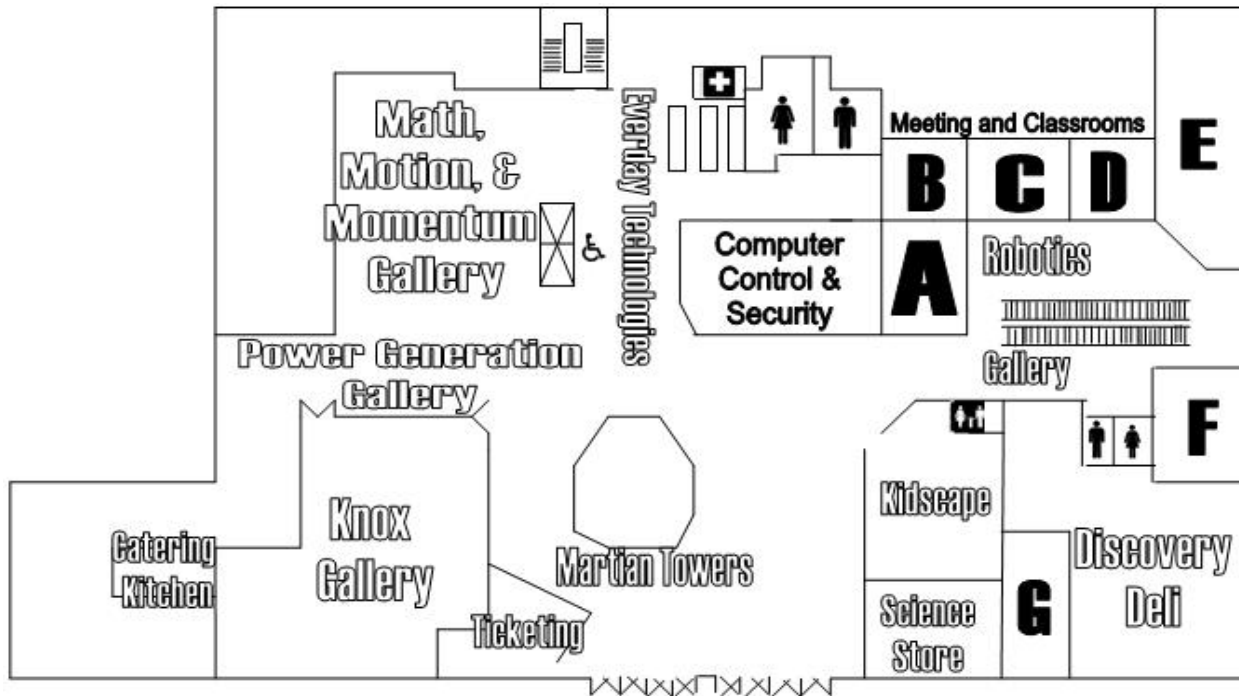



Equipment Rental Form and Vender Information

Table Size	Seating	Price	# Available	# NEEDED	TOTAL COST
6' rectangular	6	\$6 each	20	_____	_____
8' rectangular	8	\$6 each	30	_____	_____
4' round	6	\$6 each	28	_____	_____
5' round	8	\$6 each	3	_____	_____
Red Round Chairs		FREE	200	_____	_____
Red Square Chairs		FREE	150	_____	_____
Brown Leather Chairs		FREE	75	_____	_____

Audiovisual Equipment	Price	# Available	# NEEDED	TOTAL COST
Lapel Microphones	\$10 each	3	_____	_____
Hand Held Microphones	\$10 each	2	_____	_____
Portable PA system	\$50 each	2	_____	_____
LCD Projector	\$50 each	2	_____	_____
Slide Projector	\$20 each	2	_____	_____
Overhead Projector	\$20 each	3	_____	_____
TV/VCR	\$30 each	3	_____	_____
Portable Screen	\$20 each	5	_____	_____
Lectern	\$30	1	_____	_____
Custom Sound / Lighting	\$100	1	_____	_____

Other Equipment	Price	# Available	# NEEDED	TOTAL COST
Pipe and Draping	\$15 each	20	_____	_____
Dry Erase Board	\$5 each	4	_____	_____
Flip Charts	\$5 each	5	_____	_____
Easel	\$1 each	10	_____	_____
Staging	\$30 each	2	_____	_____
Dressing Room / Bath / Phone	\$25	1	_____	_____
Dressing Room / Bath	\$15	1	_____	_____
Extension Cord	\$3 each	5	_____	_____
TOTAL EQUIPMENT RENTAL COST			\$	_____

Event Vender Information

Please fill in names of vendors you will be using and add contact numbers.

Caterer _____ Florist _____

Musician (s) _____ Rental Company _____

Other _____



Facility Rental Order Form

The Facility Rental Order Form must be completed and the balance of payment must be paid at least ONE week prior to the event. The balance is made up of the remaining half of the rental fees and the equipment rental fees. Security fees if any will be invoiced after the event.

How to figure out your balance:

½ Rental Cost _____

+

Equipment Rental Fees _____

=

TOTAL COST _____

AMOUNT ENCLOSED WITH THIS FORM \$ _____

Method of Payment

I have enclosed a check _____ Money order _____

Please charge my VISA MASTERCARD AMEX

My credit card number: _____

Exp. Date: _____ Name as it appears on the card: _____

Signature _____ Date _____



Preferred Catering List

Discovery Deli on the Levee	706-722-6752
Roux's Gourmet Catering	706-724-2218
Fat Man's Café	706-733-1740
Bobby's BBQ	803-593-5900
Café 209	706-722-9692
Publix (National Hills)	706-731-5200
Delaplane's Catering	706-210-5050
French Market Grill	706-737-4865
Papa John's Pizza	706-733-7272
Walton Way Deli	706-736-4008
The Marriott on Riverwalk	706-722-8900
R.S.V.P.	706-733-0118
Poppy Seeds	706-738-6125
T.G.I. Fridays	706-736-8888
Pullman Hall	706-722-4910
Mike Smith Catering	706-210-9002
Very Vera and Company	706-860-3492
Wisteria Hill	706-722-2733
Wife Saver (Highland Ave.)	706-738-6628
Fatz Café	706-650-2421
Carrabba's Italian Grill	706-733-0123

